



These instructions also apply to:

- Motif Computer Conference Tables
- flipIT Lift Desks
- iLid DUO Desks
- Work from Home Desks

Universal Assembly Instructions

In practice, all SMARTdesks assemble using the same approach. They differ in whether they are a simple desktop, a flipIT® desktop, or flat panel FP Series desktop with monitor port and shelf. The Newpath laptop desks have contoured panels and tops, but the approach to assembly is the same,

using Confirmat Screws for assembling the cabinets and Lamello Cabineo surface connectors for attaching the top to the base cabinets.

These instructions were photo illustrated with the FI Series flipIT® models. It will show the keyboard/mouse trays being installed at an early stage when gravity is your friend. If your specific desk does not

include a keyboard/mouse tray, please disregard. This would be true for desks with the flipIT Laptop Safe®.

You will note that the main difference between the single and the double is the additional CPU bay. The approach to assembly is the same for both models. These instructions will emphasize the double.



Newpath and LT Series Desks have no keyboard trays or CPU cabinets. flipIT Laptop Safe® instructions apply after desk assembly.



The DT Series desktop may include separate instructions for accessories, such as LCD arms from the LCD arm manufacturer.



The FP Series Desk has an adjustable depth monitor shelf that installs with pins after desk assembly.



The LT Series laptop desk

The MiraVista glasstop desk has a hardwood brace for mounting the adjustable, fixed position LCD arm, and plate glass that sits in the routed viewport.

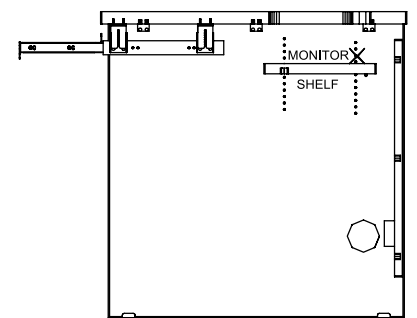
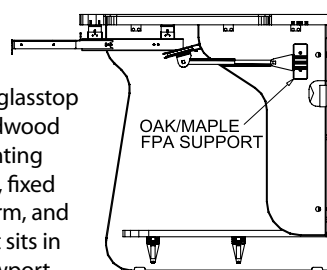

Tools Required

- Screw gun
- 4mm hexagon bit for Confirmats (provided)
- 4mm ball head hexagon bit for Lamello Cabineo surface connectors (provided)

Pre-Assembly:

Use a furniture blanket to prepare a safe workspace for finished surfaces.



Install Lamello Cabineo Surface Connectors

The milled locations are easy to identify. Simply tap the surface connectors into these locations with a hammer. Avoid full power pounding!!

The tip of the screw ships "proud" which enables easy assembly.

The diagram shows how the surface connector works. The 4mm ball end hexagon bit is used with a screw gun to make the surface connection. The ball end is used because the access to the screw head is at an angle.

Note: The 4mm ball head hexagon bit for Lamello Cabineo surface connectors can be turned around to make a straight 4mm hexagon bit for Confirmats. This is recommended to extend the tool life of the ball end.

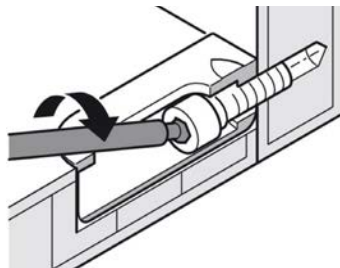

Install Levelers | Floor Glides | Locking Casters

Place black metal trim parts in position over the hole and install the threaded insert using the 6mm hex key (provided).

DO NOT USE A SCREW GUN.

Install the threaded floor glides or locking casters into the inserts.



Assembly:

On the floor, use a furniture blanket to prepare a safe workspace for finished surfaces. If using carpet, vacuum to make sure nothing sharp, like a paper clip, thumb tack, or stray wood screw is present to ruin the furniture surface.

Install keyboard/mouse tray, if the model includes it.

Eight Phillips head wood screws will be found for each keyboard/mouse tray. It is best to install this before installing cabinets, as depicted, because access to the screw locations is limited.

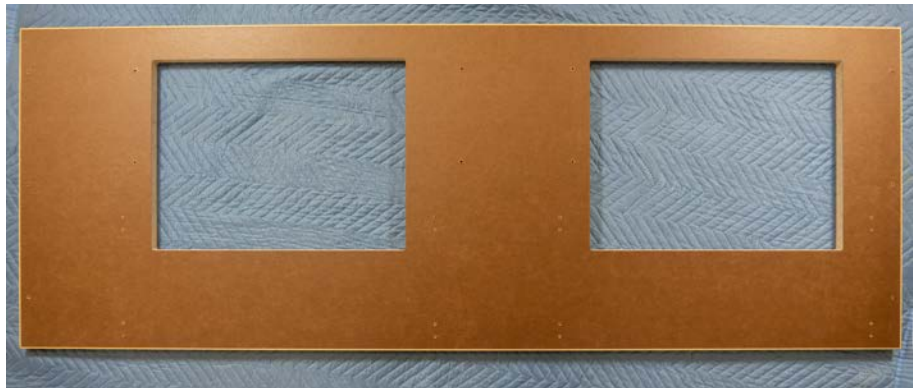

Assemble CPU Cabinets

The end CPU cabinet will be black on the inside and a laminate color chosen by the client on the outside. In this manual, the inside laminate was chosen to be fusion maple for clarity in showing the pilot hole locations. Expect the inside color to be black.

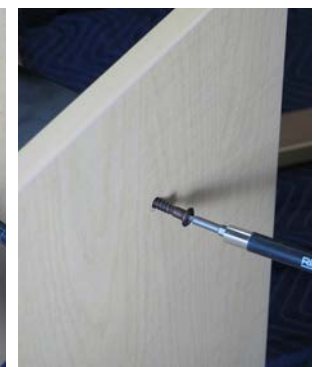
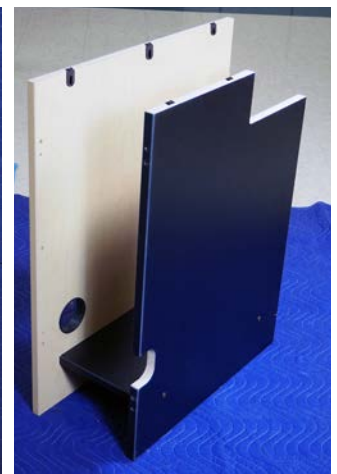
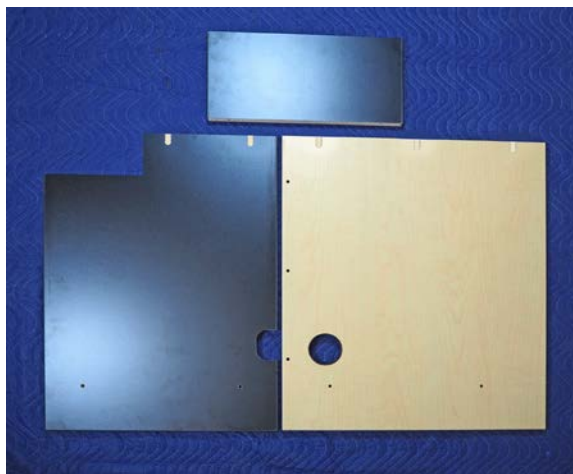

Align the shelf to the end panel, then use the 4mm hex tool in a screw gun to mount the shelf using Bronze Confirmat Screw Connectors.



CPU Cabinet Assembly, continued.

With the shelf now attached to the end panel with Confirmats, match up the shelf to the all black cabinet panel.



Complete the end panel CPU cabinet by securing with two Confirmats using the 4mm hex drive and screw gun.



The double desk has a second CPU cabinet. The photo shows the parts and the completed assembly.



It goes together exactly like the end panel:

- Align the shelf with the side panel
- Install with Confirmat screws
- Align the second side to the installed shelf
- Install with Confirmat screws.



Attach base cabinet assemblies and panels to the top with Lamello Cabineo Surface Connectors

- The screws of the surface connectors are outset to facilitate locating them in the pilot holes.
- Note the locations of the wire pass-throughs and 80mm wire grommet: they should be at the back side of the top, opposite of the user side.
- Start with the end panel with the CPU cabinet assembly.
- If you are assembling a double, set the middle CPU cabinet assembly.
- If you are assembling a single or a double, set the end panel next.
- Use the ball end 4mm hex driver in a screw gun to drive the surface connectors into the top.
- The point of using a ball end hex driver is to let you drive a square fitting at an angle. Use this design feature to your advantage.

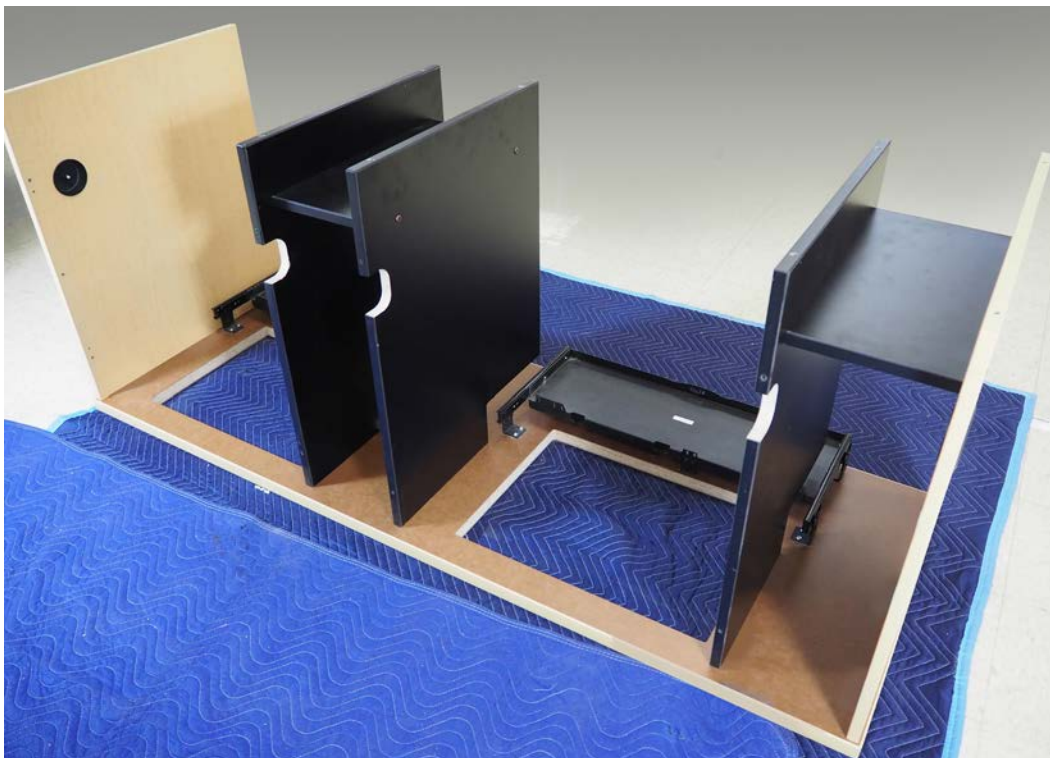
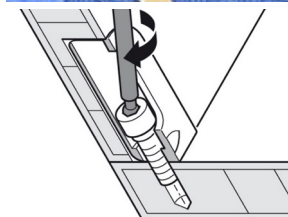
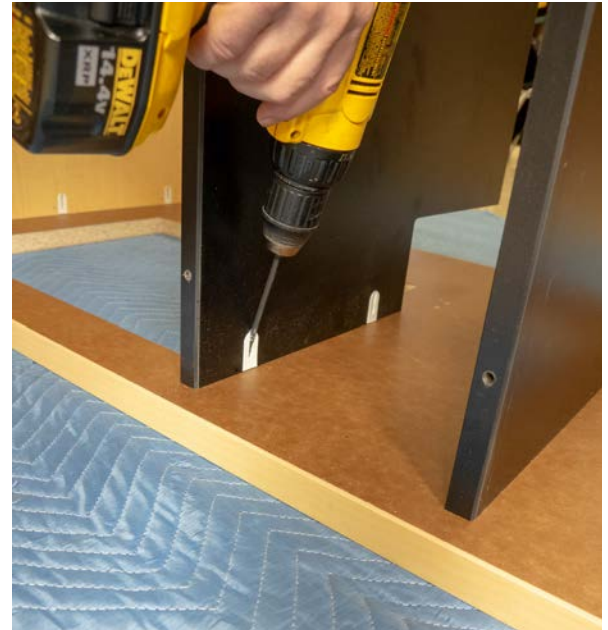
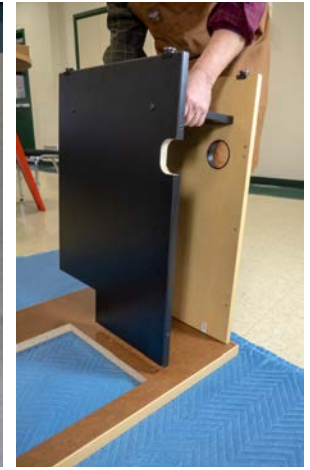

Note that the keyboard trays have been mounted prior to mounting the base panels.

If you skipped this step, please help yourself out and install them sooner, rather than later.

If you are assembling a desk for laptops, keyboard trays will not be included.

Turn desk for placement of the modesty panel



- Check to see that the pilot hole patterns of the modesty panel line up with the ones in the base panels.
- Let gravity do the work. Move the modesty panel around so the dowels locate the base cabinet(s) and panel.



- Use the straight end of the 4mm hex drive in a screw gun to install three Confirmats to secure the side panels to the modesty panel.
- Use Confirmats through the modesty panel to secure it to the CPU base cabinets.

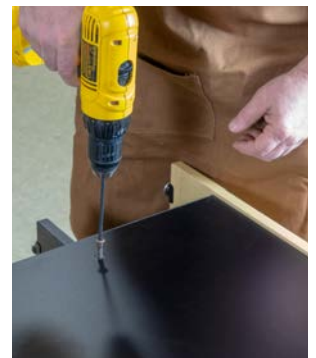
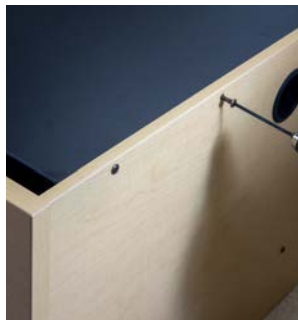



And that's it!

Please refer to flipIT® instructions if you are completing a flipIT® FI Series Desk.



Newpath and LT Series Desks have no keyboard trays or CPU cabinets. flipIT Laptop Safe® instructions apply after desk assembly.



The DT Series desktop may include separate instructions for accessories, such as LCD arms from the LCD arm manufacturer.



The FP Series Desk has an adjustable depth monitor shelf that installs with pins after desk assembly.



The LT Series laptop desk

The MiraVista glasstop desk has a hardwood brace for mounting the adjustable, fixed position LCD arm, and plate glass that sits in the routed viewport.

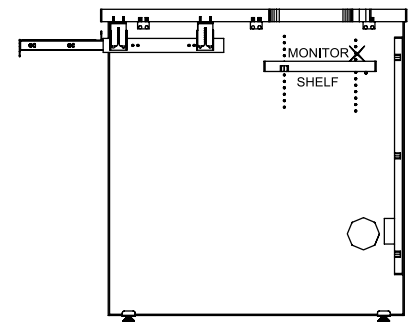
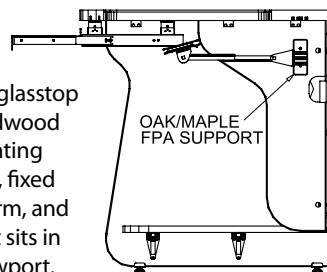

UNIVERSAL DESK ASSEMBLY INSTRUCTIONS



flipIT Laptop Safe[®]

Made in USA. US Patent No. 7,509,912

Models FIL-18-5-KIT-BL | FIL-23-5-KIT-BL | How to use template and install to factory standards



How to install into any desktop using paper template for cutting table top.

(Paper template is supplied in flipIT[®] Kit for either FIL-18 or FIL-23).

How to install into factory-cut top: start at Step 5, page 7.

Installation is illustrated using the FIL-23. The standard version, FIL-18, installs exactly the same way. The only difference is the width.

SMARTdesks[®]

www.smartdesks.com
800 770 7042

Getting Started

These installation instructions guide you through the proper way of completing the assembly of the flipIT Laptop Safe® Kit FIL-18 and FIL-23 with positive latch release and independent plunge lock.

It is especially important that the installer observe proper care in protecting surfaces from abrasion.

For any questions or assistance, please contact Technical Services at 800-770-7042.

WARNING

POWER TOOLS ARE DANGEROUS

Review the safety procedures supplied by your power tools' manufacturers. **Heed all warnings for your safety's sake. Always use safety glasses and wear proper apparel** that won't get caught in moving parts. CBT Supply, Inc. will not be held liable for misuse of tools and disregard for power tool manufacturer's safety precautions.

Tools needed for full installation

Tools needed for pre-assembly:

- Power Drill
- Tape Measure
- Commercial Grade Jigsaw
- Phillips#2 Bit Screwdriver
- 3/8" Drill Bit
- 1/8" Drill Bit
- 3/8" Open-end Wrench
- Slot Screwdriver
- Pencil
- Square and straight edge
- Masking Tape

Tools needed for installation into a factory-cut desktop only:

- Power Drill/Screw Gun
- Phillips#2 Bit Screwdriver
- 1/8" Drill Bit
- 3/8" Open-end Wrench
- Slot Screwdriver



STOP!

The installer must possess the skill to cut within the tolerance of the template layout line if no factory-made cutout is made in the table top. Do not attempt this installation without this level of craftsmanship skill.

If a factory made cut is provided, only skills of using a screwdriver and drill are required.

Space considerations for installation

FIL-18 Cut-Out & placement

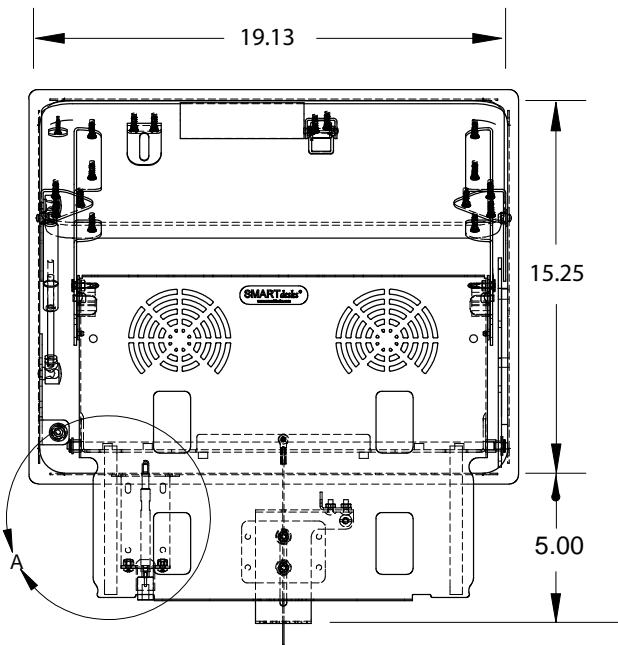

Common to both

Clearances
above and below surface

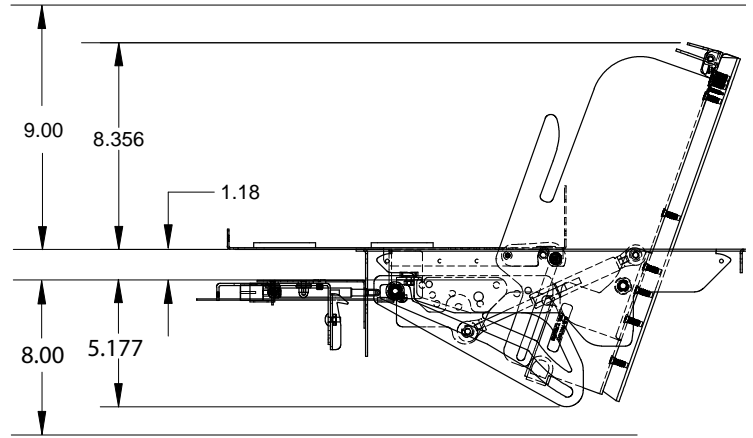

Lock pilot holes

FIL-23 Cut-Out & placement

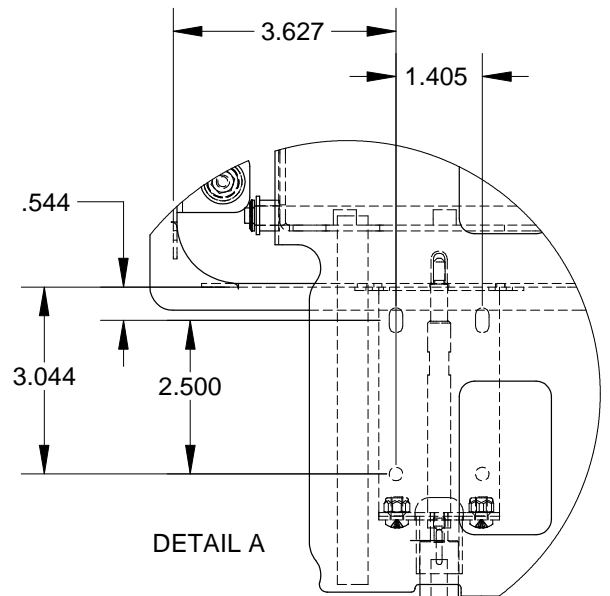
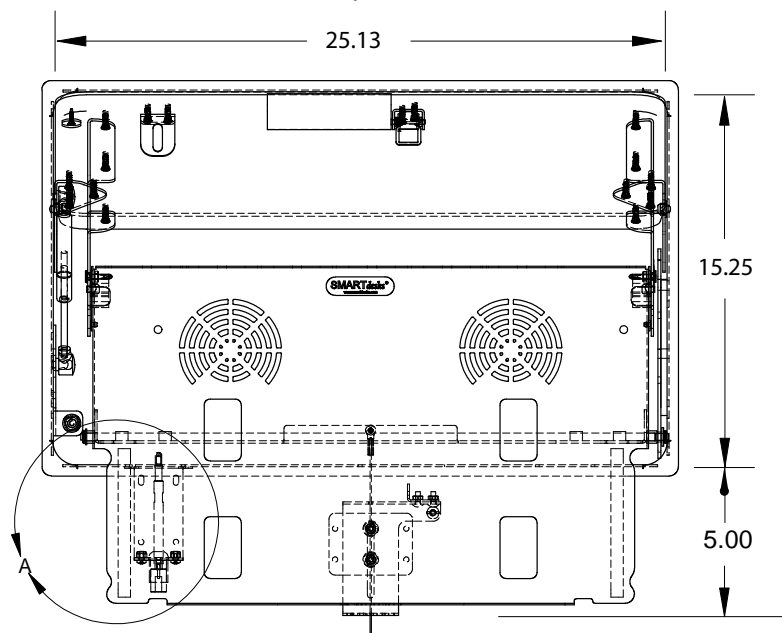

Nominal thickness of the desktop:

30mm (1.181") within a range of 1" to 1.25" for lock system to install. (25.4mm to 31.75mm)

Space between the user edge and the cutout:

5" (127mm)

Minimum top depth:

24" (660.4mm)

FIL-18 minimum width:

24" (609.6mm)

FIL-23 minimum width:

26" (660.4mm)

Minimum clearances:

Allow about 9" (288.6mm) above and 8" (203.2mm) below for clearance of the lid opening.

Cutout dimensions:

FIL-18
19.13" wide x 15.25" deep (485.9mm x 387.35mm)

FIL-23
25.13" wide x 15.25" deep (638.3mm x 387.35mm)

Parts and Hardware

The flipIT Laptop Safe® is packaged with a parts box that includes a packet of parts, the lock assembly and the latch/PULL handle assembly, this assembly manual and a template for making the cutout and pilot holes.



FIL-18 (X30238)
FIL-23 (X30206)



PULL Handle Latch Release

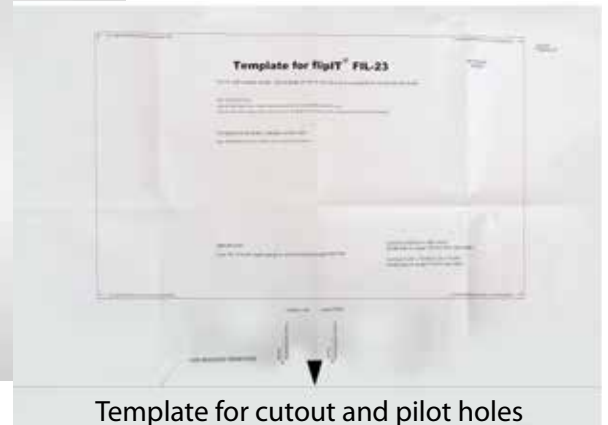

Template for cutout and pilot holes



In the lock bracket bag:

In the parts bag:

- **A** Four Neoprene pads, adhesive-backed
- **B** Two #8-32 x 5/16 Self tapping screws
- **C** Six #6 Black Oxide screws
- **D** Five #8 5/8" with #10 Thread
- **E** Four one-way wood screws

- **A** One Interlock bracket
- **B** One lock assembly
- **C** Two keys
- **D** Two one-way metal screws

Step 1: Use the template to make a cutout in the desktop

Establish a centerline for your work area using a measuring tape and mark the edge with a carpenter's square and erasable pencil.

The template indicates the dimensions of the cutout and its 5" spacing from the user edge.

Fold the paper template at the edge and locate the center arrow to the centerline you scribed on the user edge. Secure the template to the desktop with masking tape.

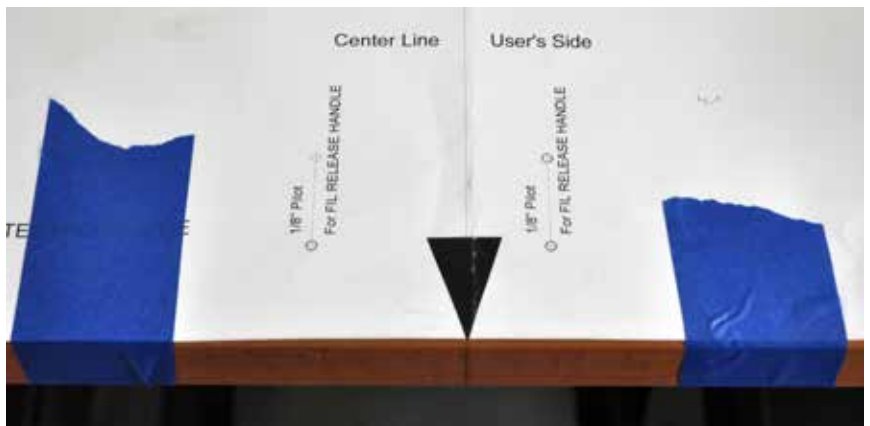

On each corner of the cutout, use an 1/8" drill to make pilot holes for centering the 3/8" holes you will make with a spade bit. Drill the 1/8" pilots through the paper template, then remove the paper template before drilling the four corner holes with the 3/8" spade bit.



Step 2: Make layout lines and cut the top

Use a straight edge and a marker to make lines for sawing the cutout.

The straight edge will be placed tangent to the 3/8" holes and the line of the marker will be tangent to the holes.

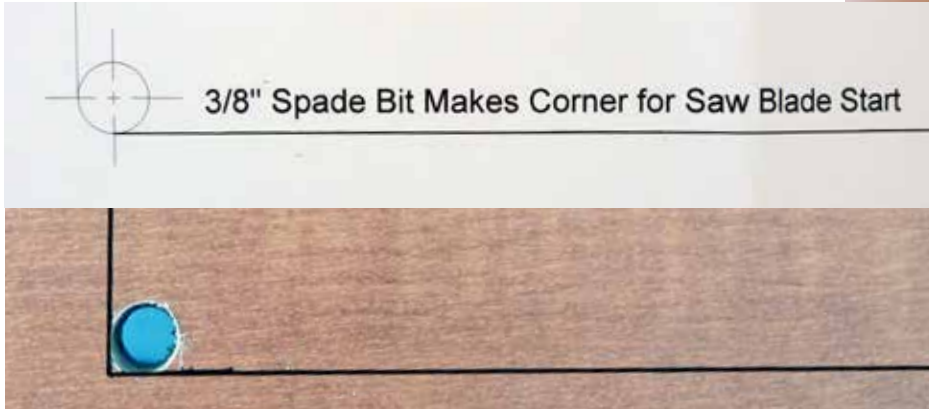

Step 3: Use saber saw to remove the line with the kerf of the blade



Use a straight saw blade and make sure the cut is 90 degrees to the surface. If the saw blade is bent and makes an angled cut (other than 90 degrees) it will bind the frame. The trim piece of the flipIT Laptop Safe will cover up any imperfections the saw makes to the laminate.



Step 4:

Mount the PULL Handle Latch Release

- Turn the desktop over to work from the underside.
- Align the template to the Center Line and secure with masking tape.
- Use 1/8" drill bit with depth gauge (masking tape used in photo) to make pilot holes for PULL Handle
- Remove template from surface
- Place PULL Handle over pilot holes
- Secure with the smaller 5/8 # 8 black oxide with Deep Thread (#10) pan head screws

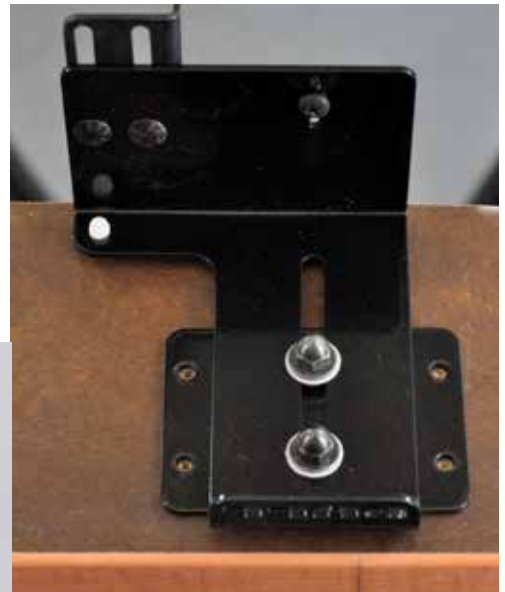

Step 5:

Install laptop safe into cutout

- Turn the desktop over to work from the top side
- Orient the laptop safe with the PULL drawer access facing the user side.
- The gas spring ships hanging loose. Do not attempt to attach the gas spring before the unit is installed into the cutout.
- Lower the unit into the cutout, but be careful to not let your fingers get in the way.
- The next step will be to open the laptop safe without the gas spring assist. This will allow access to the installation screw locations.
- **DO NOT INSTALL THE GAS SPRING YET!**



... Install laptop safe into cutout

- Press down on the back of the lid to open the laptop safe without the gas spring assist. Use your other hand to provide counter pressure so opening is controlled.

Keep pressure on the lid like this to provide access to the screw locations for making pilot holes and installing wood screws to the 3 locations on the back side of the laptop safe.

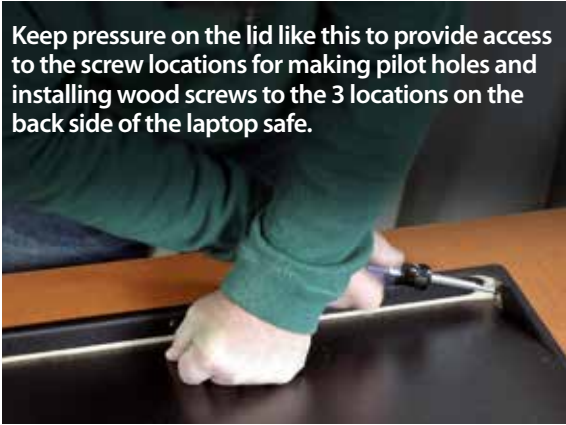

Use five #6 x 3/4 Black Oxide pan head wood screws, install at these locations. Make pilot holes first with 1/8" drill bit.



Install locations 1 and 3 first

- Holding the lid as pictured above, perform these operations:

Make a pilot hole using 1/8" bit for locations 1, 2 and 3.

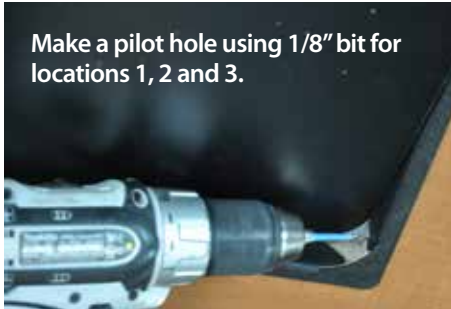

Install screws for locations 1 and 3 first...

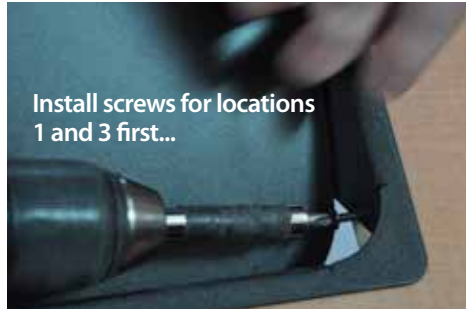

Install location 2 with a screwdriver and seat the head to its lowest profile.

If the retaining screw sits too proud, it could damage the lid. DO NOT CLOSE THE LID UNTIL FULLY SEATED FLAT.

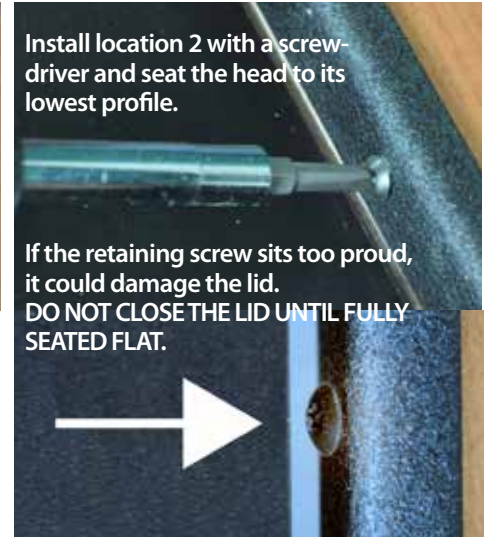

Install locations 4 & 5

- To access installation locations, PULL the drawer to open the safe. Because the gas spring is not attached, assist with your other hand by gently lifting the lid.



Use an 1/8" bit to drill pilot holes, then install wood screws in locations 4 and 5.

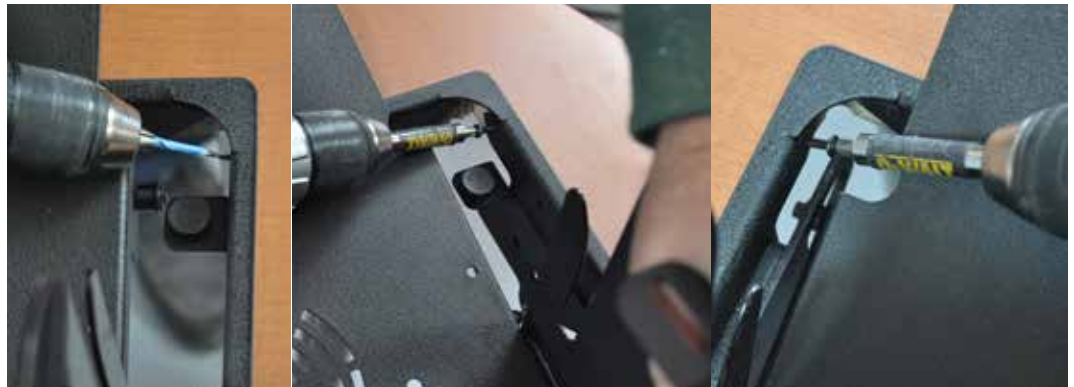

Step 6: Install gas spring

- With the metal collar of the laptop safe firmly affixed, it is now safe to install the gas spring. To do so before this step would bend the metal framework.
- If you need to disassemble the installation at any point, disconnect the gas spring before removing the rim screws to avoid damaging the unit.

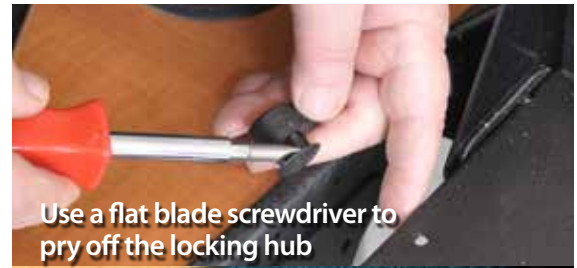

Step 7: Adjust the hook and latch

- Work under the table top with the laptop safe closed.
- Use 3/8" open wrench to loosen the hook.
- Move the latch hook so that it fits through the pivot catch window and is about 1/16-1/8" above the bottom latch window edge.
- Tighten the nuts
- Test the operation and adjust until it works smoothly.

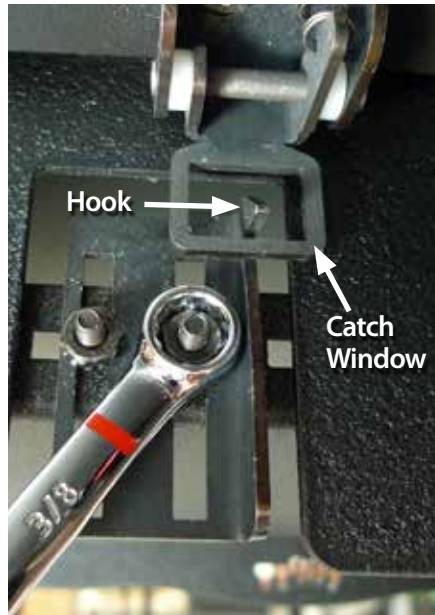

Attach the cable to release handle

Use a Phillips screwdriver to tighten the set screw and hold the cable securely.





Locate this hole pattern on the left end of the user side. The elongated slot permits adjustment for different top thicknesses.



Install both self-tapping metal screws to cut the threads, then back one off and remove the other for easy mounting of the plunge lock.

Step 8: Install the plunge lock



8 x 5/16"
Black oxide
self tapping
metal screws



Wood screws
8 3/4" black oxide pan
head phillips drive



One-Way wood screws
(optional)



Place the lock assembly and snug up the screw you left backed off.



Install the second screw with the lock in position.



This is how the lock assembly should be positioned prior to attaching it to the desktop.



Make pilot holes with 1/8" drill and depth gauge (note masking tape)



Install wood screws. Check operation before replacing wood screws with One-Way screws.
Technical Support: 800-770-7042

Plunge Lock Keeper Plate

- The plunge lock works like a deadbolt lock and locking plate
- Install the lock plate with two Euro screws
- The holes of this part are elongated to allow fine adjustment and adaptation to desktop thicknesses
- Test the operation that it clears the deadbolt when retracted and locks effectively when extended.
- Option: One-way screws are provided for the lock assembly. Use a 3/8" open end wrench and appropriate screw drivers and replace these one at a time, if extra measure of security is desired.



The deadbolt is shown extended.



Step 9:

Install laptop pads

- flipIT Laptop Safe® is dimensioned to support a variety of laptop designs. Neoprene pads have been supplied to provide padded protection and ventilation, but they need to be installed to the needs of the laptops to be used.
- First, place the laptop where it will be most often used, which is right next to the front lip. Place the pads on top of the laptop to visualize where they will need to go. Keep in mind if it might be likely to also use laptops of larger or smaller sizes. If this will be the case, choose a position that will provide this range of support.
- Remove the laptop and the backing paper from the pads and rest them in place.
- Test fit the laptop, and move the pads as needed, then press them in place.



Keep in mind how the laptop will be connected to power and data, even when stored. Wires pass through the "mushroom tops" that also provide the back wall of the chamber.

A telecom plate with customized connectors may be custom ordered.



Here is how the flipIT Laptop Safe® operates:

- Make sure you PULL where the handles tell you. The laptop safe opens in two steps: PULL HANDLE and PULL DRAWER.

Push to Lock.
Unlock with key.



The lock unlocks with a key and locks by pushing the plunge lock button. It is not necessary to lock the unit to keep the lid closed.



To open flipIT Laptop Safe, PULL the handle.

PULL the handle.
PULL the drawer.



The flipIT Laptop Safe will open this far, revealing the PULL instruction on the drawer tray.



PULL the drawer tray toward you. **DO NOT LIFT BY THE LID.** Doing so will destroy the unit and void the warranty.

Laptop is ready
for use.



PULL the tray drawer to this position. The lid will open easily, assisted by the gas spring.



The laptop may now be opened and is ready for use. This process takes seconds.

To Close: ↓



Close the laptop and move it to the rear of the drawer.



Grasp the top lid and pull it toward you. When you get to the end of the travel, gently push the tray in.



Close the lid. The latch will automatically engage to keep the lid closed.



To lock, push the lock button. No key is required to lock.